

EM4027

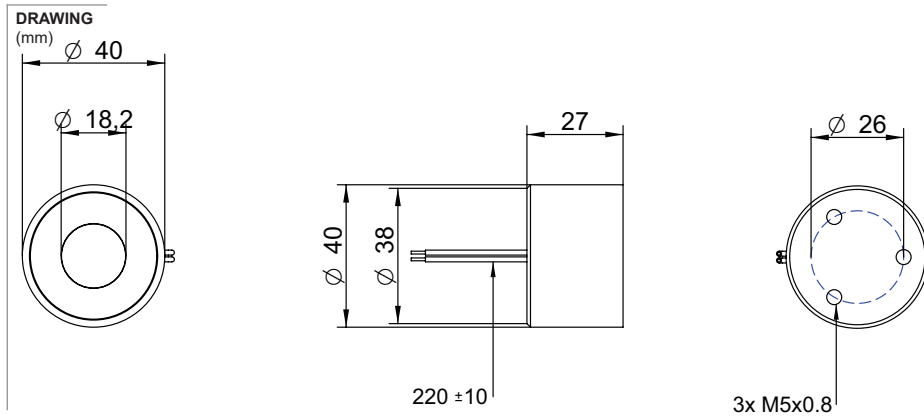

PHOTO



MODEL NO. DESIGNATION

EM4027 - VOLTAGE

Example: EM4027-12V

SOLENOID DATA	
Voltage	12V or 24V
Holding force	approx. 200N
Weight	230g
Nominal power	6W

ADDITIONAL DATA	
Insulation grade	B
Dielectric withstand test	600V r.m.s.
Duty cycle	100%

SOLENOID FEATURES AND STANDARD DATA		
	STANDARD	CUSTOMIZATION OPTIONS
Type	Electromagnet	
Cable	Flying wire 220mm	Length, type and connector
Voltage	12 or 24 VDC @ 100% ED	
Life time	500.000 single strokes	
Operating temperature	-20° ... +45°C	Up to +180°C
Manufacturing quality standards	ISO9001, IATF16949	
RoHS compliance	Yes	
CE approval	No	
UL approval	No	